

Programmable, Off-Line, PWM Controller

FEATURES

- All Control, Driving, Monitoring, and Protection Functions Included
- Low-Current Off Line Start Circuit
- Voltage Feed Forward or Current Mode Control
- High Current Totem Pole Output
- 50% Absolute Max Duty Cycle
- PWM Latch for Single Pulse Per Period
- Pulse-by-Pulse Current Limiting plus Shutdown for Over-Current Fault
- No Start-Up or Shutdown Transients
- Slow Turn-On Both Initially and After Fault Shutdown
- Shutdown Upon Over or Under Voltage Sensing
- Latch Off or Continuous Retry After Fault
- 1% Reference Accuracy
- 500kHz Operation
- 18 Pin DIL or 20 Pin PLCC Package

DESCRIPTION

The UC1851 family of PWM controllers are optimized for off-line primary side control. These devices include a high current totem pole output stage and a toggle flip-flop for absolute 50% duty cycle limiting. In all other respects this line of controllers is pin for pin compatible with the UC1841 series. Inclusion of all major housekeeping functions in these high performance controllers makes them ideal for use in cost sensitive applications.

Important features of these controllers include low current start-up, linear feed-forward for constant volt-second operation, and compatibility with both voltage or current mode control. In addition, these devices include a programmable start threshold, as well as programmable over-voltage, under-voltage, and over current fault thresholds. The fault latch on these devices can be configured for automatic restart, or latched off response to a fault.

These devices are packaged in 18-pin plastic or ceramic dual-in-line packages, or for surface mount applications, a 20 Pin PLCC. The UC1851 is characterized for -55°C to +125°C operation while the UC2851 and UC3851 are designed for -40°C to +85°C and 0°C to +70°C, respectively.

BLOCK DIAGRAM

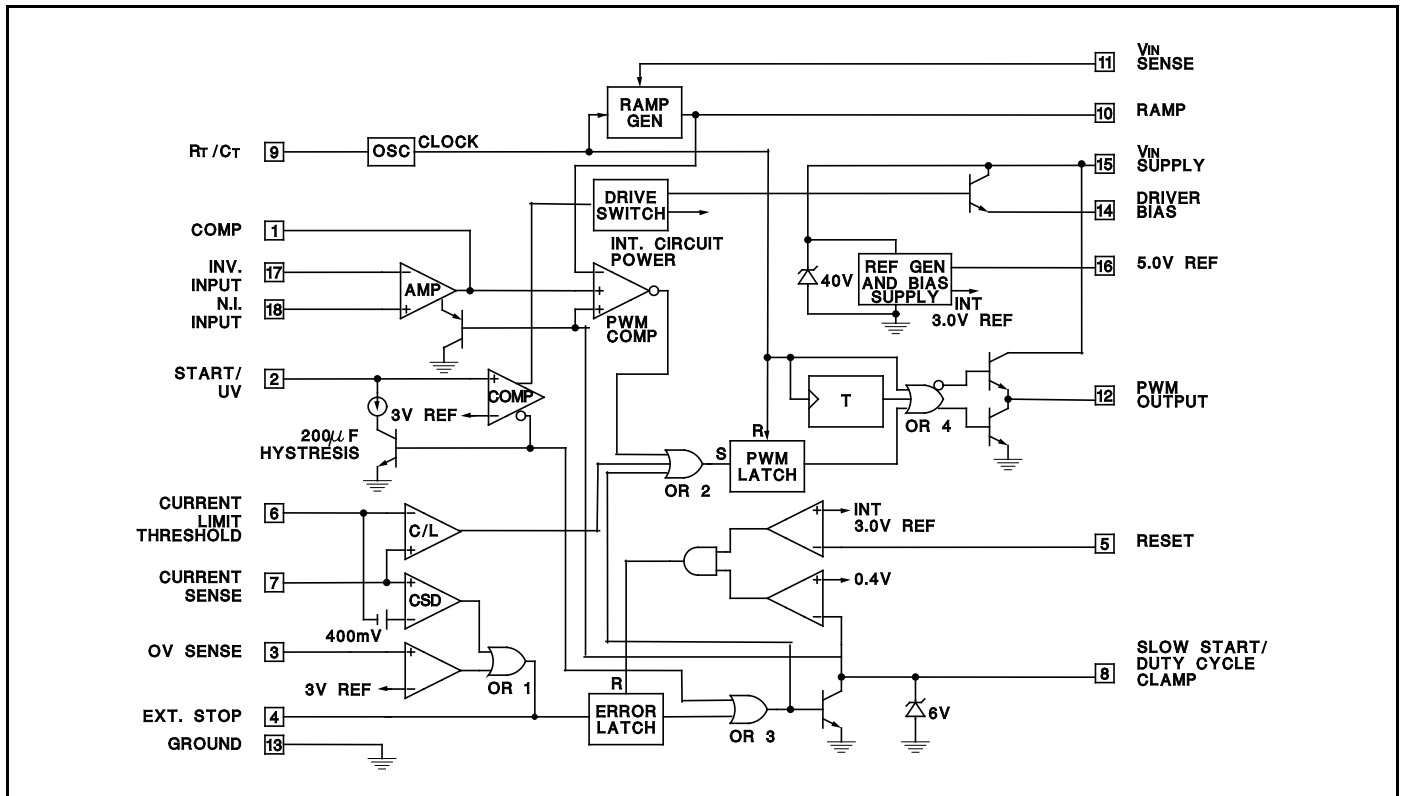

ABSOLUTE MAXIMUM RATINGS (Note 1)

Supply Voltage, +VIN (Pin 15)	
Voltage Driven	+32V
Current Driven, 100mA maximum	Self-limiting
PWM Output Voltage (Pin 12)	40V
PWM Output Current, Steady-State (Pin 12)	400mA
PWM Output Peak Energy Discharge	20μJoules
Driver Bias Current (Pin 14)	-200mA
Reference Output Current (Pin 16)	-50mA
Slow-Start Sink Current (Pin 8)	20mA
VIN Sense Current (Pin 11)	10mA
Current Limit Inputs (Pins 6 & 7)	-0.5 to +5.5V
Stop Input (Pin 4)	-0.3 to +5.5V

Comparator Inputs
(Pins 1–7, 9–11, 16). Internally clamped at 12V
Power Dissipation at TA = 25°C (Note 3). 1000mW
Power Dissipation at TC = 25°C (Note 3). 2000mW
Operating Junction Temperature. -55°C to +150°C
Storage Temperature Range. -65°C to +150°C
Lead Temperature (Soldering, 10 sec) +300°C
Note 1: All voltages are with respect to ground, Pin 13.
Currents are positive-into, negative-out of the specified terminal
Note 2: All pin numbers are referenced to DIL-18 package.
Note 3: Consult Packaging Section of Databook for thermal limitations and considerations of package.

CONNECTION DIAGRAMS

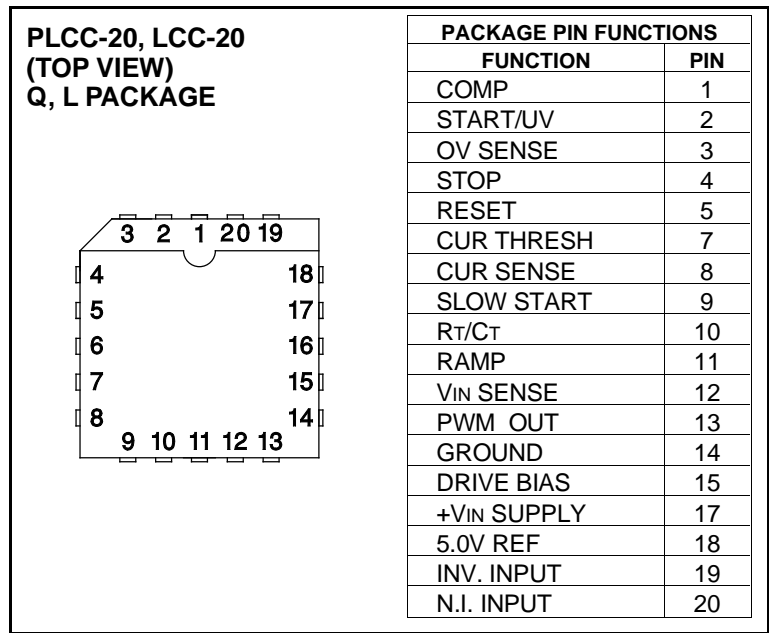
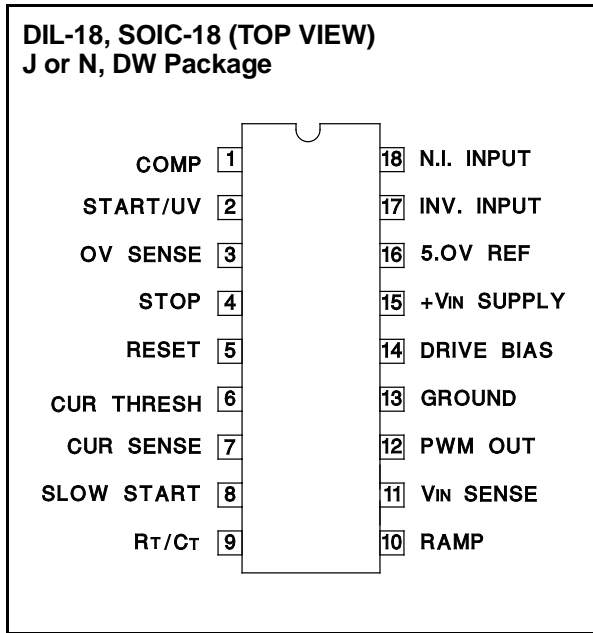

ELECTRICAL CHARACTERISTICS: Unless otherwise stated, these specifications apply for TA = -55°C to +125°C for the UC1851, -40°C to +85°C for the UC2851, and 0°C to 70°C for the UC3851; VIN = 20V, RT = 20kΩ, CT = .001 mfd, RR = 10kΩ, CR = .001mfd. Current Limit Threshold = 200mV, TA = TJ.

PARAMETER	TEST CONDITIONS	UC1851 / UC2851			UC3851			UNITS
		MIN	TYP	MAX	MIN	TYP	MAX	
Power Inputs								
Start-Up Current	VIN = 30V, Pin 2 = 2.5V		4.5	6		4.5	6	mA
Operating Current	VIN = 30V, Pin 2 = 3.5V		15	21		15	21	mA
Supply OV Clamp	VIN = 20mA	33	39	45	33	39	45	V
Reference Section								
Reference Voltage	TJ = 25°C	4.95	5.0	5.05	4.9	5.0	5.1	V
Line Regulation	VIN = 8 to 30V		10	15		10	20	mV
Load Regulation	IL = 0 to 10mA		10	20		10	30	mV
Total Ref Variation	Over Operating Temperature Range	4.9		5.1	4.85		5.15	V
Short Circuit Current	VREF = 0, TJ = 25°C		-80	-100		-80	-100	mA
Oscillator								
Nominal Frequency	TJ = 25°C	47	50	53	45	50	55	kHz
Voltage Stability	VIN = 8 to 30V		0.5	1		0.5	1	%
Total Ref Variation	Over Operating Temperature Range	45		55	43		57	kHz
Maximum Frequency	RT = 2kΩ, CT = 330pF	500			500			kHz

ELECTRICAL CHARACTERISTICS: Unless otherwise stated, these specifications apply for $T_A = -55^\circ\text{C}$ to $+125^\circ\text{C}$ for the UC1851, -40°C to $+85^\circ\text{C}$ for the UC2851, and 0°C to 70°C for the UC3851; $V_{IN} = 20\text{V}$, $R_T = 20\text{k}\Omega$, $C_T = .001\text{ mfd}$, $R_R = 10\text{k}\Omega$, $C_R = .001\text{ mfd}$. Current Limit Threshold = 200mV , $T_A = T_J$.

PARAMETER	TEST CONDITIONS	UC1851 / UC2851			UC3851			UNITS
		MIN	TYP	MAX	MIN	TYP	MAX	
Ramp Generator								
Ramp Current, Minimum	$I_{SENSE} = -10\mu\text{A}$		-11	-14		-11	-14	μA
Ramp Current, Maximum	$I_{SENSE} = 1.0\text{mA}$	-0.9	-95		-0.9	-95		mA
Ramp Valley		0.3	0.4	0.6	0.3	0.4	0.6	V
Ramp Peak	Clamping Level	3.9	4.2	4.5	3.9	4.2	4.5	V
Error Amplifier								
Input Offset Voltage	$V_{CM} = 5.0\text{V}$		0.5	5		2	10	mV
Input Bias Current			0.5	2		1	5	μA
Input Offset Current				0.5			0.5	μA
Open Loop Gain	$\Delta V_O = 1$ to 3V	60	66		60	66		dB
Output Swing (Max Output \leq Ramp Peak - 100mV)	Minimum Total Range	0.3		3.5	0.3		3.5	V
CMRR	$V_{CM} = 1.5$ to 5.5V	70	80		70	80		dB
PSRR	$V_{IN} = 8$ to 30V	70	80		70	80		dB
Short Circuit Current	$V_{COMP} = 0\text{V}$		-4	-10		-4	-10	mA
Gain Bandwidth (Note 1)	$T_J = 25^\circ\text{C}$, $A_{VOL} = 0\text{dB}$	1	2		1	2		MHz
Slew Rate (Note 1)	$T_J = 25^\circ\text{C}$, $A_{VCL} = 0\text{dB}$		0.8			0.8		$\text{V}/\mu\text{s}$
PWM Section								
Continuous Duty Cycle Range (other than zero) (Note 1)	Minimum Total Continuous Range Ramp Peak $< 4.2\text{V}$	2		46	2		46	$\%$
Output High Level	$I_{SOURCE} = 20\text{mA}$	18	18.5		18	18.5		V
	$I_{SOURCE} = 200\text{mA}$	17	18.5		17	18.5		V
Rise Time (Note 1)	$T_J = 25^\circ\text{C}$, $C_L = 1\text{nF}$		50	150		50	150	ns
Fall Time (Note 1)	$T_J = 25^\circ\text{C}$, $C_L = 1\text{nF}$		50	150		50	150	ns
Output Saturation	$I_{OUT} = 20\text{mA}$		0.2	0.4		0.2	0.4	V
	$I_{OUT} = 200\text{mA}$		1.7	2.2		1.7	2.2	V
Comparator Delay (Note 1)	Pin 8 to Pin 12, $T_J = 25^\circ\text{C}$, $R_L = 1\text{k}\Omega$		300	500		300	500	ns
Sequencing Functions								
Comparator Thresholds	Pins 2, 3, 5	2.8	3.0	3.2	2.8	3.0	3.2	V
Input Bias Current	Pins 3, 5 = 0V		-1.0	-4.0		-1.0	-4.0	μA
Input Leakage	Pins 3, 5 = 10V		0.1	2.0		0.1	2.0	μA
Start/UV Hysteresis Current	Pin 2 = 2.5V	170	200	220	170	200	230	μA
Ext. Stop Threshold	Pin 4	0.8	1.6	2.4	0.8	1.6	2.4	V
Error Latch Activate Current	Pin 4 = 0V , Pin 3 $> 3\text{V}$		-120	-200		-120	-200	μA
Driver Bias Saturation Voltage, $V_{IN-V_{OH}}$	$I_B = -50\text{mA}$		2	3		2	3	V
Driver Bias Leakage	$V_B = 0\text{V}$		-0.1	-10		-0.1	-10	μA
Slow-Start Saturation	$I_S = 10\text{mA}$		0.2	0.5		0.2	0.5	V
Slow-Start Leakage	$V_S = 4.5\text{V}$		0.1	2.0		0.1	2.0	μA
Current Control								
Current Limit Offset			0	5		0	10	mV
Current Shutdown Offset		370	400	430	360	400	440	mV
Input Bias Current	Pin 7 = 0V		-2	-5		-2	-5	μA
Common Mode Range (Note 1)		-0.4		3.0	-0.4		3.0	V
Current Limit Delay (Note 1)	$T_J = 25^\circ\text{C}$, Pin 7 to 12, $R_L = 1\text{k}$		200	400		200	400	ns

Note 1: Guaranteed by design. Not 100% tested in production.

FUNCTIONAL DESCRIPTION

PWM CONTROL	
1. Oscillator	Generates a fixed-frequency internal clock from an external R_T and C_T . Frequency = $\frac{K_C}{R_T C_T}$ where K_C is a first-order correction factor $\approx 0.3 \log(C_T \times 10^{12})$.
2. Ramp Generator:	Develops linear ramp with slope defined externally by $\frac{dV}{dT} = \frac{\text{sense voltage}}{R R C_R}$. C_R is normally selected $\leq C_T$ and its value will have some effect upon valley duty cycle. Limiting the minimum value for I_{SENSE} into pin 11 will establish a maximum duty cycle clamp. C_R terminal can be used as an input port for current mode control.
3. Error Amplifier	Conventional operational amplifier for closed-loop gain and phase compensation. Low output impedance; unity-gain stable. The output is held low by the slow start voltage at turn on in order to minimize overshoot.
4. Reference Generator:	Precision 5.0V for internal and external usage to 50mA. Tracking 3.0V reference for internal usage only with nominal accuracy of $\pm 2\%$. 40V clamp zener for chip OV protection, 100mA maximum current.
5. PWM Comparator:	Generates output pulse which starts at termination of clock pulse and ends when the ramp input crosses the lowest of two positive inputs.
6. PWM Latch:	Terminates the PWM output pulse when set by inputs from either the PWM comparator, the pulse-by-pulse comparator, or the error latch. Resets with each internal clock pulse.
7. PWM Output Switch:	Totem pole output stage capable of sourcing and sinking 1 amp peak current. The active "on" state is high.
SEQUENCING FUNCTIONS	
1. Start/UV Sense:	With an increasing voltage, this comparator generates a turn-on signal and releases the slow start clamp at a start threshold. With a decreasing voltage, it generates a turn-off command at a lower level separated by a 200 μ A hysteresis current.
2. Drive Switch:	Disables most of the chip to hold internal current consumption low, and Driver Bias OFF, until input voltage reaches start threshold.
3. Driver Bias:	Supplies drive to external circuitry upon start-up.
4. Slow Start:	Clamps low to hold PWM OFF. Upon release, rises with rate controlled by $R_S C_S$ for slow increase of output pulse width. Can also be used as an alternate maximum duty cycle clamp with an external voltage divider.
PROTECTION FUNCTIONS	
1. Error Latch:	When set by momentary input, this latch insures immediate PWM shutdown and hold off until reset. Inputs to Error Latch are: a. OV > 3.2V (Typically 3V) b. Stop > 2.4V (Typically 1.6V) c. Current Sense 400mV over threshold. (Typical). Error Latch resets when slow start voltage falls to 0.4V if Reset Pin < 2.8V. With Pin 5 > 3.2V, Error Latch will remain set.
2. Current Limiting:	Differential input comparator terminates individual output pulses each time sense voltage rises above threshold. When sense voltage rises to 400mV (typical) above threshold, a shutdown signal is sent to Error Latch.
3. External Stop:	A voltage over 2.4 will set the Error Latch and hold the output off. A voltage less than 0.8V will defeat the error latch and prevent shutdown. A capacitor here will slow the action of the error latch for transient protection by providing a Typical Delay of 13ms/ μ F.

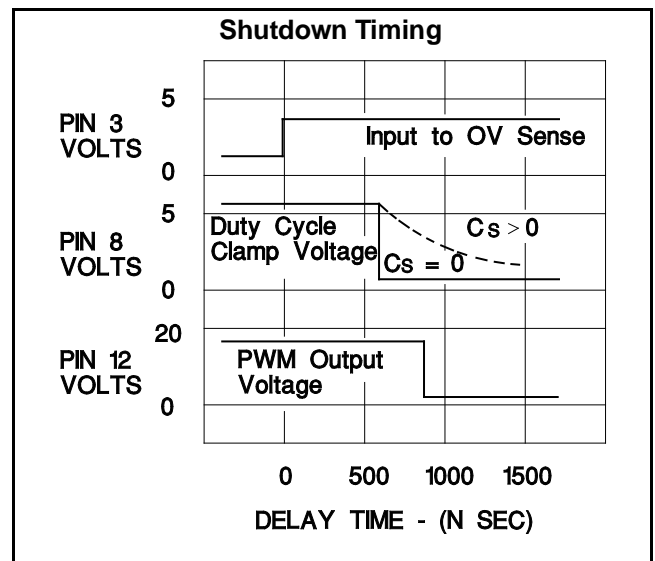
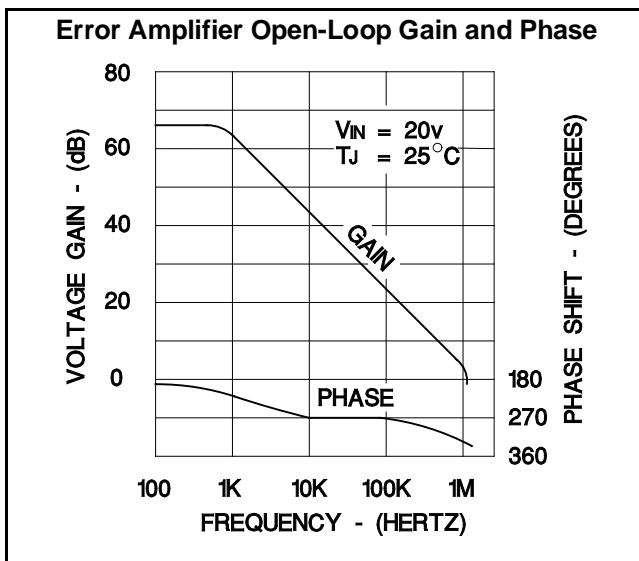
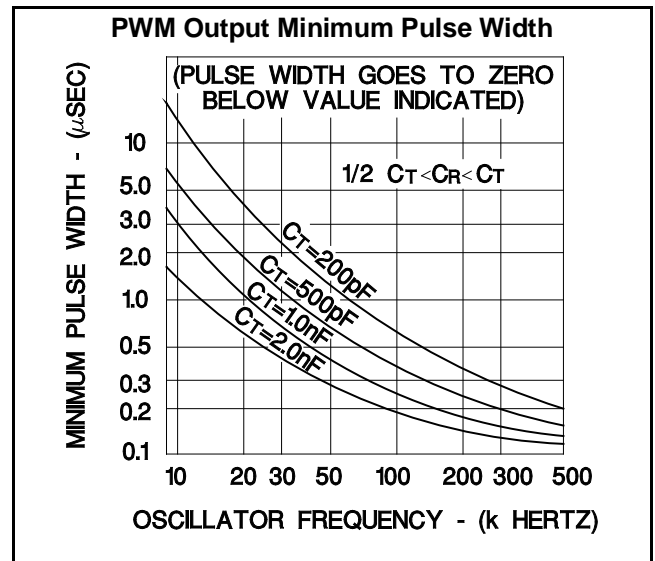
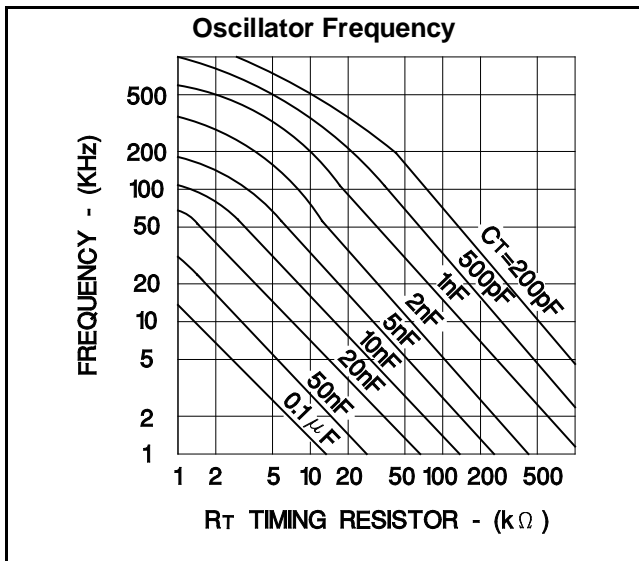
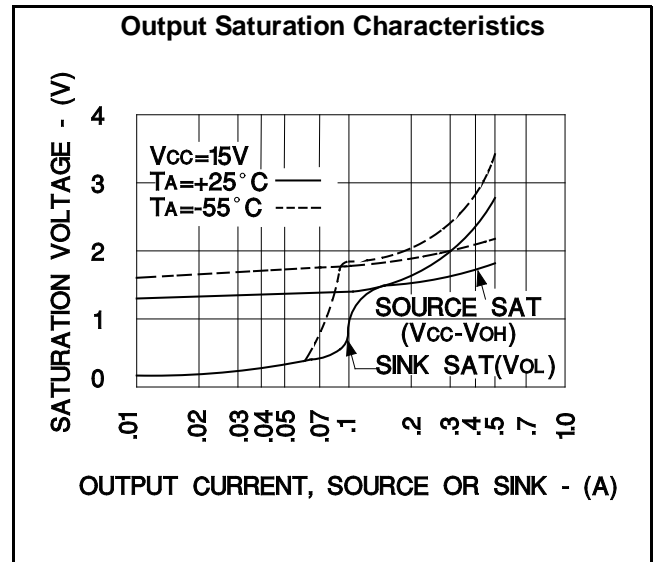
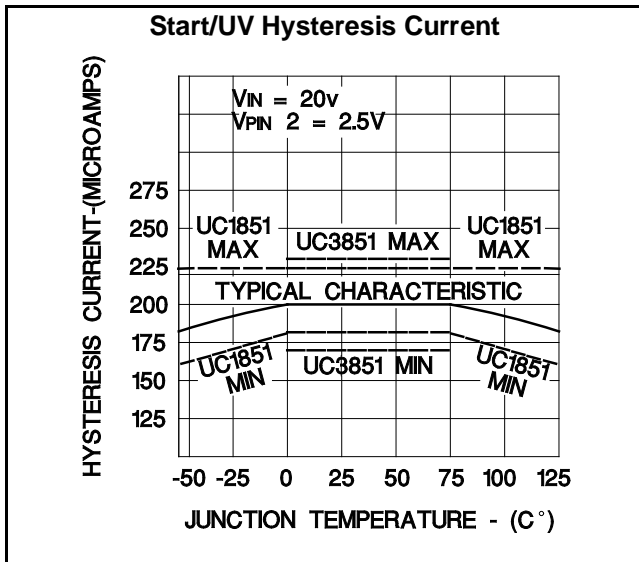

PACKAGING INFORMATION

Orderable Device	Status ⁽¹⁾	Package Type	Package Drawing	Pins	Package Qty	Eco Plan ⁽²⁾	Lead/Ball Finish	MSL Peak Temp ⁽³⁾
5962-9558601MVA	OBSOLETE	CDIP	J	18		TBD	Call TI	Call TI
UC1851J	OBSOLETE	CDIP	J	18		TBD	Call TI	Call TI
UC1851J883B	OBSOLETE	CDIP	J	18		TBD	Call TI	Call TI
UC2851DW	ACTIVE	SOIC	DW	18	40	Green (RoHS & no Sb/Br)	CU NIPDAU	Level-2-260C-1 YEAR
UC2851DWG4	ACTIVE	SOIC	DW	18	40	Green (RoHS & no Sb/Br)	CU NIPDAU	Level-2-260C-1 YEAR
UC2851N	ACTIVE	PDIP	N	18	20	Green (RoHS & no Sb/Br)	CU NIPDAU	N / A for Pkg Type
UC2851NG4	ACTIVE	PDIP	N	18	20	Green (RoHS & no Sb/Br)	CU NIPDAU	N / A for Pkg Type
UC3851DW	ACTIVE	SOIC	DW	18	40	Green (RoHS & no Sb/Br)	CU NIPDAU	Level-2-260C-1 YEAR
UC3851DWG4	ACTIVE	SOIC	DW	18	40	Green (RoHS & no Sb/Br)	CU NIPDAU	Level-2-260C-1 YEAR
UC3851DWTR	ACTIVE	SOIC	DW	18	2000	Green (RoHS & no Sb/Br)	CU NIPDAU	Level-2-260C-1 YEAR
UC3851DWTRG4	ACTIVE	SOIC	DW	18	2000	Green (RoHS & no Sb/Br)	CU NIPDAU	Level-2-260C-1 YEAR
UC3851N	ACTIVE	PDIP	N	18	20	Green (RoHS & no Sb/Br)	CU NIPDAU	N / A for Pkg Type
UC3851NG4	ACTIVE	PDIP	N	18	20	Green (RoHS & no Sb/Br)	CU NIPDAU	N / A for Pkg Type

⁽¹⁾ The marketing status values are defined as follows:

ACTIVE: Product device recommended for new designs.

LIFEBUY: TI has announced that the device will be discontinued, and a lifetime-buy period is in effect.

NRND: Not recommended for new designs. Device is in production to support existing customers, but TI does not recommend using this part in a new design.

PREVIEW: Device has been announced but is not in production. Samples may or may not be available.

OBSOLETE: TI has discontinued the production of the device.

⁽²⁾ Eco Plan - The planned eco-friendly classification: Pb-Free (RoHS), Pb-Free (RoHS Exempt), or Green (RoHS & no Sb/Br) - please check <http://www.ti.com/productcontent> for the latest availability information and additional product content details.

TBD: The Pb-Free/Green conversion plan has not been defined.

Pb-Free (RoHS): TI's terms "Lead-Free" or "Pb-Free" mean semiconductor products that are compatible with the current RoHS requirements for all 6 substances, including the requirement that lead not exceed 0.1% by weight in homogeneous materials. Where designed to be soldered at high temperatures, TI Pb-Free products are suitable for use in specified lead-free processes.

Pb-Free (RoHS Exempt): This component has a RoHS exemption for either 1) lead-based flip-chip solder bumps used between the die and package, or 2) lead-based die adhesive used between the die and leadframe. The component is otherwise considered Pb-Free (RoHS compatible) as defined above.

Green (RoHS & no Sb/Br): TI defines "Green" to mean Pb-Free (RoHS compatible), and free of Bromine (Br) and Antimony (Sb) based flame retardants (Br or Sb do not exceed 0.1% by weight in homogeneous material)

⁽³⁾ MSL, Peak Temp. -- The Moisture Sensitivity Level rating according to the JEDEC industry standard classifications, and peak solder temperature.

Important Information and Disclaimer:The information provided on this page represents TI's knowledge and belief as of the date that it is provided. TI bases its knowledge and belief on information provided by third parties, and makes no representation or warranty as to the accuracy of such information. Efforts are underway to better integrate information from third parties. TI has taken and continues to take reasonable steps to provide representative and accurate information but may not have conducted destructive testing or chemical analysis on incoming materials and chemicals. TI and TI suppliers consider certain information to be proprietary, and thus CAS numbers and other limited information may not be available for release.

In no event shall TI's liability arising out of such information exceed the total purchase price of the TI part(s) at issue in this document sold by TI to Customer on an annual basis.

TAPE AND REEL INFORMATION



QUADRANT ASSIGNMENTS FOR PIN 1 ORIENTATION IN TAPE



*All dimensions are nominal

Device	Package Type	Package Drawing	Pins	SPQ	Reel Diameter (mm)	Reel Width W1 (mm)	A0 (mm)	B0 (mm)	K0 (mm)	P1 (mm)	W (mm)	Pin1 Quadrant
UC3851DWTR	SOIC	DW	18	2000	330.0	24.4	10.9	12.0	2.7	12.0	24.0	Q1

TAPE AND REEL BOX DIMENSIONS



*All dimensions are nominal

Device	Package Type	Package Drawing	Pins	SPQ	Length (mm)	Width (mm)	Height (mm)
UC3851DWTR	SOIC	DW	18	2000	346.0	346.0	41.0

IMPORTANT NOTICE

Texas Instruments Incorporated and its subsidiaries (TI) reserve the right to make corrections, modifications, enhancements, improvements, and other changes to its products and services at any time and to discontinue any product or service without notice. Customers should obtain the latest relevant information before placing orders and should verify that such information is current and complete. All products are sold subject to TI's terms and conditions of sale supplied at the time of order acknowledgment.

TI warrants performance of its hardware products to the specifications applicable at the time of sale in accordance with TI's standard warranty. Testing and other quality control techniques are used to the extent TI deems necessary to support this warranty. Except where mandated by government requirements, testing of all parameters of each product is not necessarily performed.

TI assumes no liability for applications assistance or customer product design. Customers are responsible for their products and applications using TI components. To minimize the risks associated with customer products and applications, customers should provide adequate design and operating safeguards.

TI does not warrant or represent that any license, either express or implied, is granted under any TI patent right, copyright, mask work right, or other TI intellectual property right relating to any combination, machine, or process in which TI products or services are used. Information published by TI regarding third-party products or services does not constitute a license from TI to use such products or services or a warranty or endorsement thereof. Use of such information may require a license from a third party under the patents or other intellectual property of the third party, or a license from TI under the patents or other intellectual property of TI.

Reproduction of TI information in TI data books or data sheets is permissible only if reproduction is without alteration and is accompanied by all associated warranties, conditions, limitations, and notices. Reproduction of this information with alteration is an unfair and deceptive business practice. TI is not responsible or liable for such altered documentation. Information of third parties may be subject to additional restrictions.

Resale of TI products or services with statements different from or beyond the parameters stated by TI for that product or service voids all express and any implied warranties for the associated TI product or service and is an unfair and deceptive business practice. TI is not responsible or liable for any such statements.

TI products are not authorized for use in safety-critical applications (such as life support) where a failure of the TI product would reasonably be expected to cause severe personal injury or death, unless officers of the parties have executed an agreement specifically governing such use. Buyers represent that they have all necessary expertise in the safety and regulatory ramifications of their applications, and acknowledge and agree that they are solely responsible for all legal, regulatory and safety-related requirements concerning their products and any use of TI products in such safety-critical applications, notwithstanding any applications-related information or support that may be provided by TI. Further, Buyers must fully indemnify TI and its representatives against any damages arising out of the use of TI products in such safety-critical applications.

TI products are neither designed nor intended for use in military/aerospace applications or environments unless the TI products are specifically designated by TI as military-grade or "enhanced plastic." Only products designated by TI as military-grade meet military specifications. Buyers acknowledge and agree that any such use of TI products which TI has not designated as military-grade is solely at the Buyer's risk, and that they are solely responsible for compliance with all legal and regulatory requirements in connection with such use.

TI products are neither designed nor intended for use in automotive applications or environments unless the specific TI products are designated by TI as compliant with ISO/TS 16949 requirements. Buyers acknowledge and agree that, if they use any non-designated products in automotive applications, TI will not be responsible for any failure to meet such requirements.

Following are URLs where you can obtain information on other Texas Instruments products and application solutions:

Products

Amplifiers	amplifier.ti.com
Data Converters	dataconverter.ti.com
DSP	dsp.ti.com
Clocks and Timers	www.ti.com/clocks
Interface	interface.ti.com
Logic	logic.ti.com
Power Mgmt	power.ti.com
Microcontrollers	microcontroller.ti.com
RFID	www.ti-rfid.com
RF/IF and ZigBee® Solutions	www.ti.com/lprf

Applications

Audio	www.ti.com/audio
Automotive	www.ti.com/automotive
Broadband	www.ti.com/broadband
Digital Control	www.ti.com/digitalcontrol
Medical	www.ti.com/medical
Military	www.ti.com/military
Optical Networking	www.ti.com/opticalnetwork
Security	www.ti.com/security
Telephony	www.ti.com/telephony
Video & Imaging	www.ti.com/video
Wireless	www.ti.com/wireless

Mailing Address: Texas Instruments, Post Office Box 655303, Dallas, Texas 75265
Copyright © 2008, Texas Instruments Incorporated